

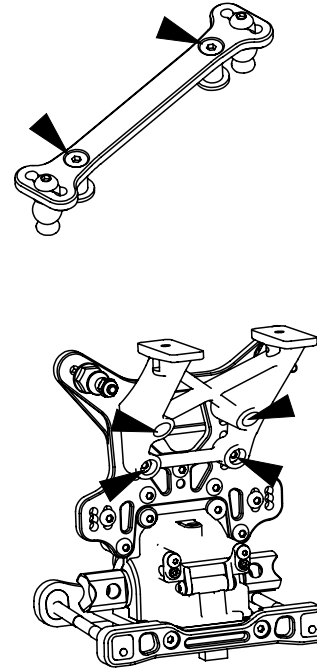

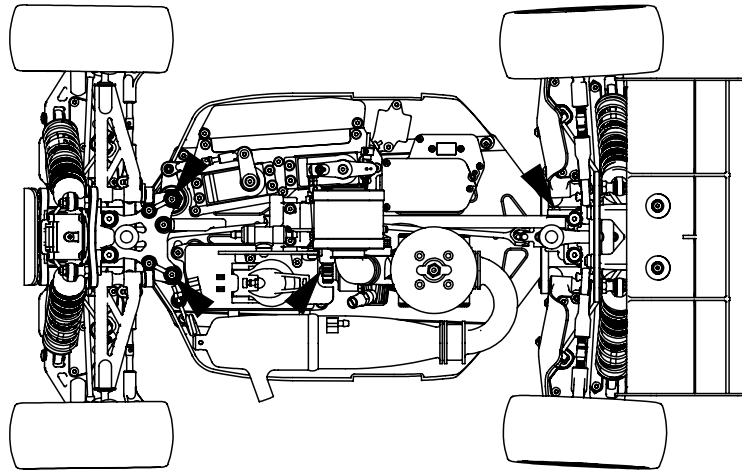









## E2821 TITANIUM SCREW SET A チタンスクリューセットA





-  SiG3x6T 3pcs.
-  SiG3x8T 33pcs.
-  SiG3x10T 7pcs.
-  SiG3x12T 21pcs.
-  SiG3x16T 5pcs.
-  SiG3x18T 4pcs.
-  SiG3x23T 2pcs.
-  SJG3x8T 14pcs.
-  SJG3x10T 5pcs.
-  SJG3x12T 22pcs.
-  SJG3x16T 6pcs.

\*The allowed place must use the screw of the kit attachment.  
\*矢印で示した箇所はキット付属ビスを使用してください。

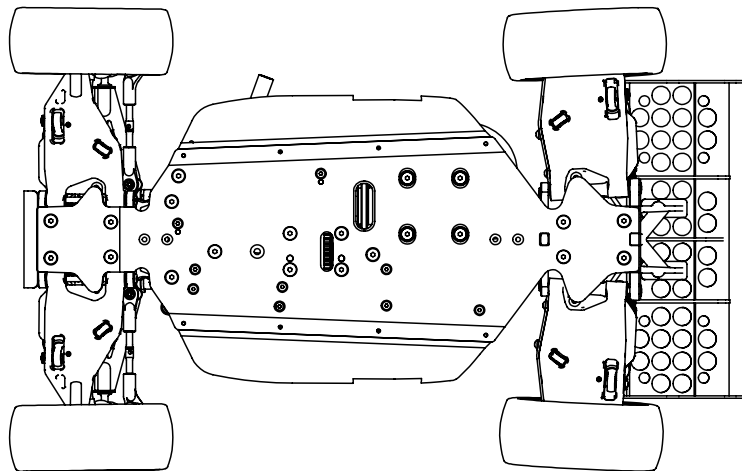
## E2822 TITANIUM SCREW SET B チタンスクリューセットB



-  SiG3x5T 8pcs.
-  SJG3x10T 9pcs.
-  SJG4x15T 8pcs.
-  SJG4x20T 4pcs.