

DRIVER		
DATE		
TRACK		

TRACTION

LOW <input type="checkbox"/>	MEDIUM <input type="checkbox"/>	HIGH <input type="checkbox"/>
------------------------------	---------------------------------	-------------------------------

LAYOUT

SLOW <input type="checkbox"/>	MIXED <input type="checkbox"/>	FAST <input type="checkbox"/>
-------------------------------	--------------------------------	-------------------------------

ENGINE

TYPE		
GLOW PLUG/FUEL PIPE/MANIFOLD		

CLUTCH SETTINGS

SHOE#/BELL#		
CLEARANCE(mm) / AXIALPLAY(mm)		
SPRING#/TENSION(mm)		

TYRES

CONTROLLED

FRONT		BRAND	REAR	
LEFT	RIGHT		LEFT	RIGHT

		SHORE DIAMETER START DIAMETER 5min		
--	--	------------------------------------	--	--

SHOCK ABSORBERS

FRONT	REAR
-------	------

PISTON		PISTON	
OIL		OIL	
SPRING		SPRING	

ANTI ROLL BAR FRONT

2,2 <input type="checkbox"/>	2,3 <input type="checkbox"/>	2,4 <input type="checkbox"/>	2,5 <input type="checkbox"/>
------------------------------	------------------------------	------------------------------	------------------------------

ANTI ROLL BAR REAR

2,8 <input type="checkbox"/>	2,9 <input type="checkbox"/>	3,0 <input type="checkbox"/>
------------------------------	------------------------------	------------------------------

SERVO SAVER POSITION

FORWARD <input type="checkbox"/>	REARWARD <input type="checkbox"/>	<input type="checkbox"/>	<input type="checkbox"/>	<input type="checkbox"/>
----------------------------------	-----------------------------------	--------------------------	--------------------------	--------------------------

PINION 1st

15T <input type="checkbox"/>	16T <input type="checkbox"/>
------------------------------	------------------------------

PINION 2nd

19T <input type="checkbox"/>	20T <input type="checkbox"/>
------------------------------	------------------------------

SPUR 1st

48T <input type="checkbox"/>	49T <input type="checkbox"/>	50T <input type="checkbox"/>
------------------------------	------------------------------	------------------------------

SPUR 2nd

45T <input type="checkbox"/>	46T <input type="checkbox"/>	47T <input type="checkbox"/>
------------------------------	------------------------------	------------------------------

STEERING ROD POSITION

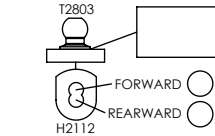

CASTER ANGLE (mm)

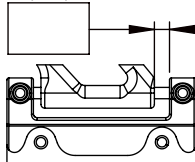

UPPER ARM POSITION

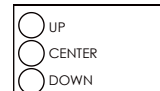

CAMBER



SHOCK HOLE

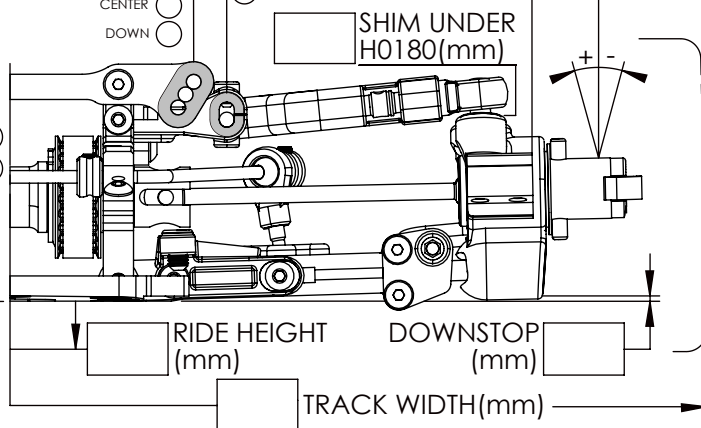
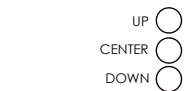

SHOCK/UPPER ROD POSITION

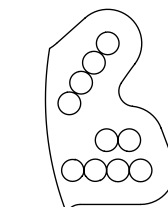

SHOCK POSITION H2115



LOWER ARM POSITION

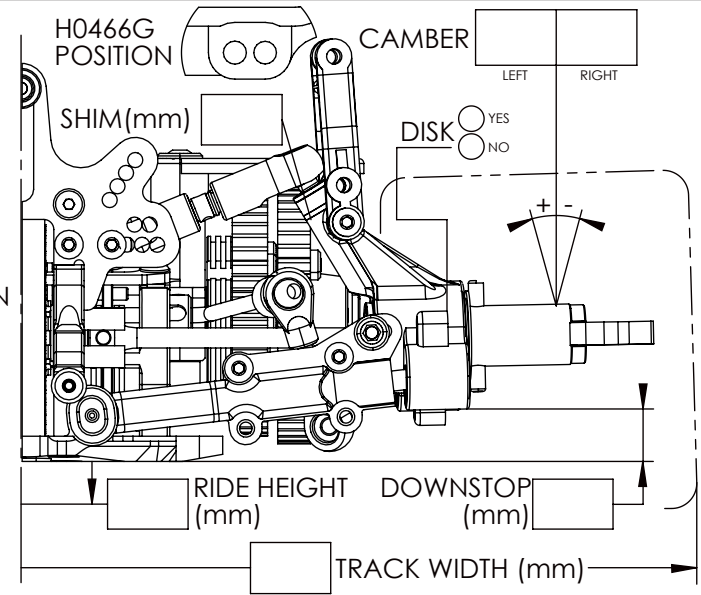
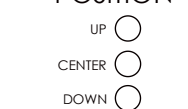

FRONT TOE

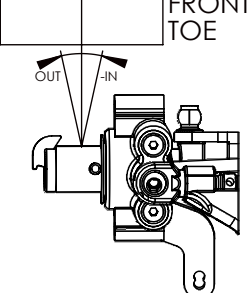

RADIOPLATE FLEX

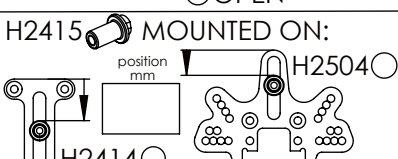
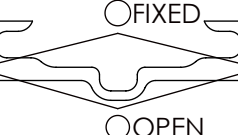

REAR TOE

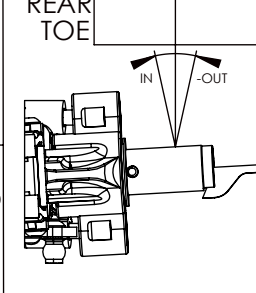

WEIGHT DISTRIBUTION

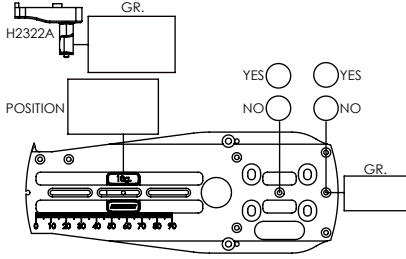

AERO/SETTING

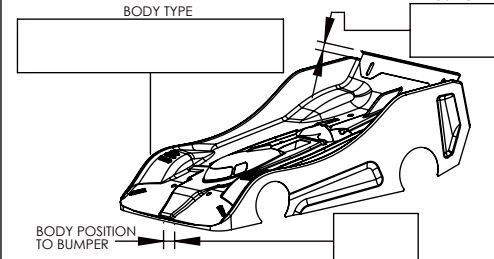

NOTES: