

Name: _____
 Date: _____
 Track: _____

Track conditions
 Size: Open Med. Tight
 Traction: High Med. Low
 Surface: Smooth Med. Bumpy

Result
 Race time / Lap: _____
 Best lap (1Lap): _____

Front suspension

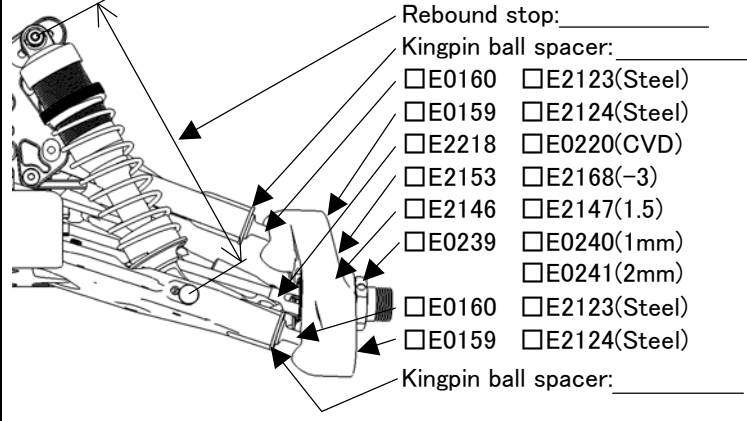

Ride height: _____
 Toe angle: _____
 Lower arm plate: _____
E2144A,B
E2154(CFRP 1mm)
E2155(CFRP 1.2mm)
 Anti roll bar: _____
 Upper arm spacer: _____

 Lower arm spacer: _____

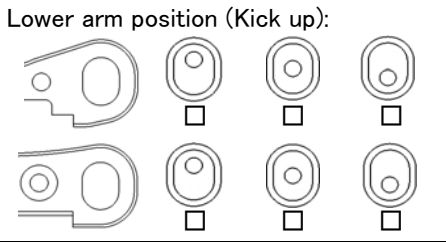
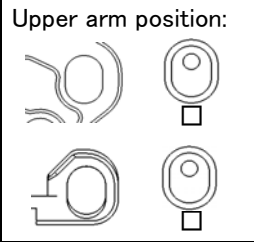

Front shocks

Piston: _____ Oil: _____
 Spring: _____
 Shock position: _____

 Pivot ball position: Front Rear
 Damper stay: E2562(Aluminum)
E2565(CFRP)

Steering ackerman

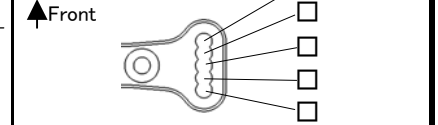

Front upper plate

E2148D E2158(CFRP)
Servo saver arm
E2301A E2310(Aluminum)

Rear suspension

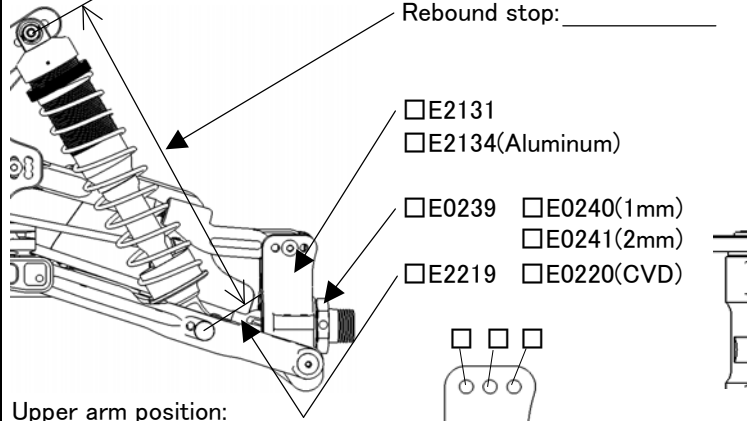

Ride height: _____
 Camber angle: _____
 Lower arm plate: _____
E2145A,B
E2156(CFRP 1mm)
E2157(CFRP 1.2mm)
 Anti roll bar: _____
 Lower arm spacer: _____

 Upright spacer: _____

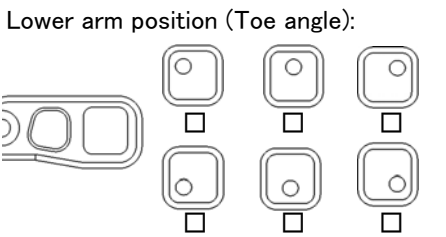
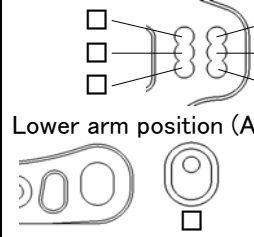

Rear shocks

Piston: _____ Oil: _____
 Spring: _____
 Shock position: _____

 Pivot ball position: Front Rear
 Damper stay: E2563(Aluminum)
E2566(CFRP)

Center shaft

E2228,E2229
E0223,E0259(CVD) E2261,E2262
Tension rod
 Front: E2107A(Long) E2107B(Short)
 Rear: E2148C E0803(Rubber)

Weight

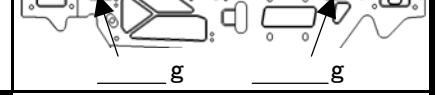

Engine

Type: _____ Plug: _____ Reducer: _____
 Muffler: _____ Fuel: _____ Gasket: _____
 Engine mount: E0701(Standard) E2713(One Piece)

Diff. gear

Oil _____
 Front: 44/13T 42/12T
 Rear: 44/13T 42/12T
 Center: 44T 46T
47T 48T

Tires

Type: _____ Front _____ Rear _____
 Compound: _____
 Inserts: _____
 Wheel: _____

Clutch

Clutch bell:		<input type="checkbox"/> 13T	<input type="checkbox"/> 14T		
		φ 0.9	φ 0.95	φ 1.0	φ 1.05
A	<input type="checkbox"/> C0754 <input type="checkbox"/> E0704 <input type="checkbox"/> E0710				
B	<input type="checkbox"/> C0754 <input type="checkbox"/> E0704 <input type="checkbox"/> E0710				
C	<input type="checkbox"/> C0754 <input type="checkbox"/> E0704 <input type="checkbox"/> E0710				

Body/Wing

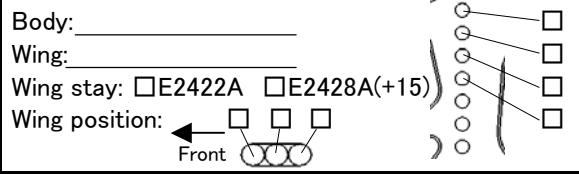

Comments

.....

