

Name: Yusuke Sugiura
Date: O.S. Off-Road Challenge 2019
Track: KRC Off-Road Circuit

Track conditions

Size: Open Med. Tight
 Traction: High Med. Low
 Surface: Smooth Med. Bumpy

Result

Race time / Lap: _____
 Best lap (1Lap): _____

Front suspension

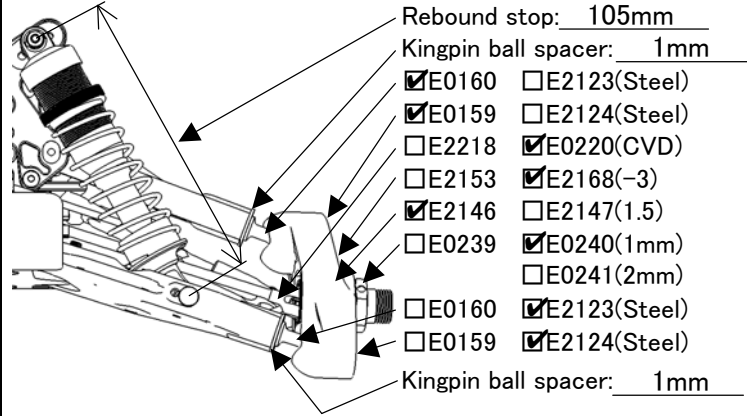

Upper arm position:

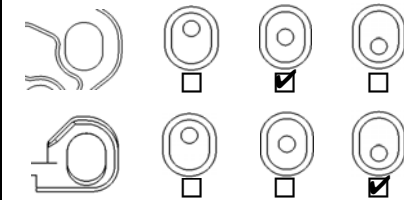

Lower arm position (Kick up):

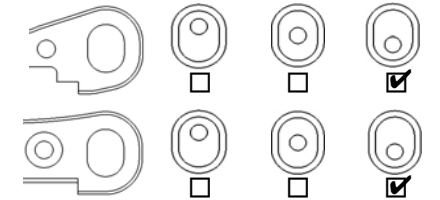

Ride height: 24mm
 Toe angle: out 1°
 Lower arm plate: E2144A,B
 E2154(CFRP 1mm)
 E2155(CFRP 1.2mm)
 Anti roll bar: ϕ 2.3
 Upper arm spacer: 2mm
 Lower arm spacer: 1mm

Front shocks

Piston: 1.3x8 Oil: #600
 Spring: ϕ 1.6 L70-9.25
 Shock position:

 Pivot ball position: Front Rear
 Damper stay: E2562(Aluminum)
 E2565(CFRP)

Steering ackerman

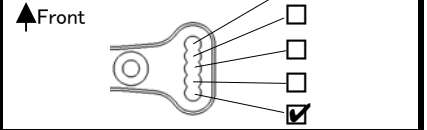

Front upper plate

E2148D E2158(CFRP)

Servo saver arm

E2301A E2310(Aluminum)

Rear suspension

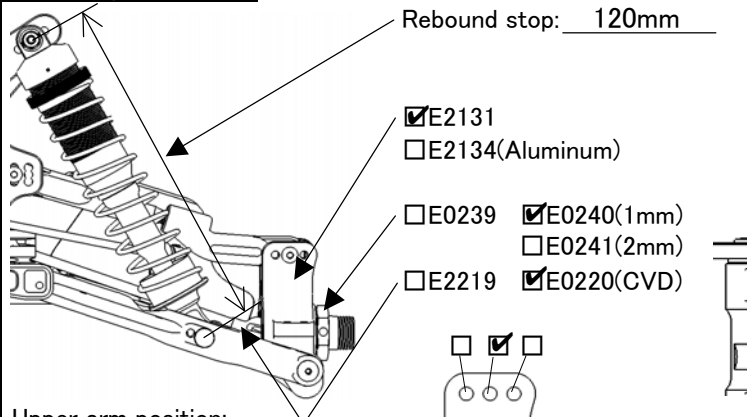

Upper arm position:

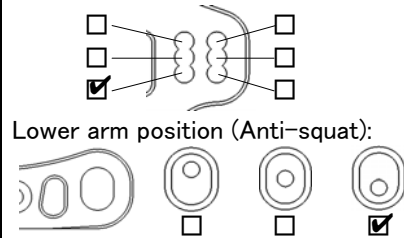

Lower arm position (Toe angle):

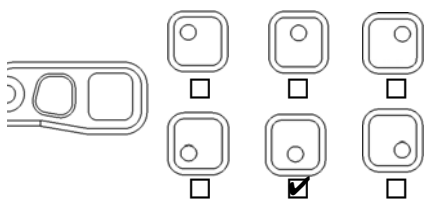

Ride height: 29mm
 Camber angle: -2.5°
 Lower arm plate: E2145A,B
 E2156(CFRP 1mm)
 E2157(CFRP 1.2mm)
 Anti roll bar: ϕ 2.7
 Lower arm spacer: 0
 Upright spacer: 1mm

Rear shocks

Piston: 1.3x8 Oil: #550
 Spring: ϕ 1.6 L86-10.75
 Shock position:

 Pivot ball position: Front Rear
 Damper stay: E2563(Aluminum)
 E2566(CFRP)

Center shaft

E2228,E2229
 E0223,E0259(CVD) E2261,E2262

Tension rod

Front: E2107A(Long) E2107B(Short)
 Rear: E2148C E0803(Rubber)

Weight

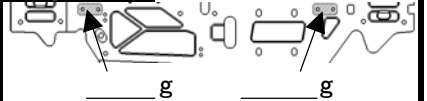

Engine

Type: O.S. B2103 Type-S Plug: P3 Reducer: 6mm
 Muffler: 2100 Fuel: KLOTZ Gasket: _____
 Engine mount: E0701(Standard) E2713(One Piece)

Diff. gear

Oil
 Front: 44/13T 42/12T #4,000
 Rear: 44/13T 42/12T #2,000
 Center: 44T 46T #4,000
 47T 48T

Tires

	Front	Rear
Type:	Pro-Line Blockade	Pro-Line Blockade
Compound:	X4	X4
Inserts:	Pro-Line	Pro-Line
Wheel:	Mugen	Mugen

Clutch

Clutch bell: 13T 14T

	ϕ 0.9	ϕ 0.95	ϕ 1.0	ϕ 1.05	ϕ 1.1
A	<input type="checkbox"/> C0754	<input type="checkbox"/> E0704	<input checked="" type="checkbox"/> E0710	<input type="checkbox"/>	<input type="checkbox"/>
B	<input type="checkbox"/> C0754	<input type="checkbox"/> E0704	<input checked="" type="checkbox"/> E0710	<input type="checkbox"/>	<input type="checkbox"/>
C	<input checked="" type="checkbox"/> C0754	<input type="checkbox"/> E0704	<input type="checkbox"/> E0710	<input type="checkbox"/>	<input type="checkbox"/>

Body/Wing

Body: Mugen
 Wing: Mugen
 Wing stay: E2422A E2428A(+15)
 Wing position:

Comments

F/C/Rともデフの中のシムは0枚。
 Without any shims in the front, center, and rear differential.