

Name: Robert Batlle
Date: DNC 2018
Track: Fear Farm, AZ, USA

Track conditions
 Size: Open Med. Tight
 Traction: High Med. Low
 Surface: Smooth Med. Bumpy

Result
 Race time / Lap: _____
 Best lap (1Lap): _____

Front suspension

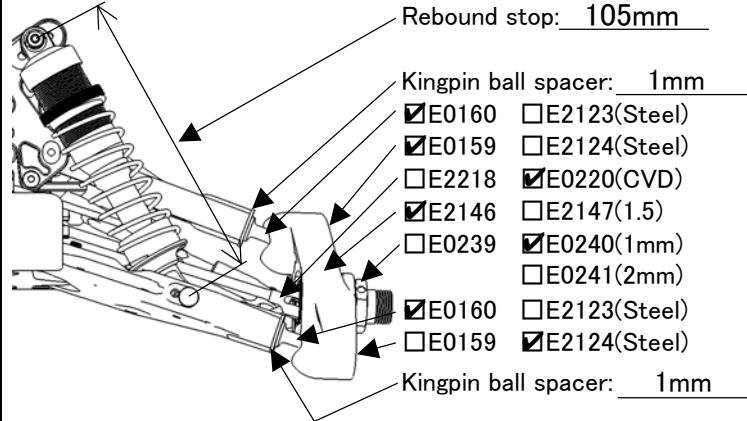

Ride height: 24mm
 Toe angle: 25.5mm
 Lower arm plate:
 E2144A,B
 E2154(CFRP 1mm)
 E2155(CFRP 1.2mm)
 Anti roll bar: ϕ 2.3
 Upper arm spacer: Middle

Front shocks

Piston: 8x1.2 Oil: #450
 Spring: 9.0
 Shock position:

 Pivot ball position: Front Rear
 Damper stay: E2562(Aluminum)
 E2565(CFRP)

Upper arm position:

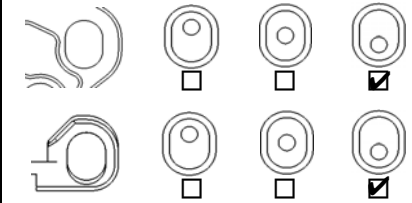

Lower arm position (Kick up):

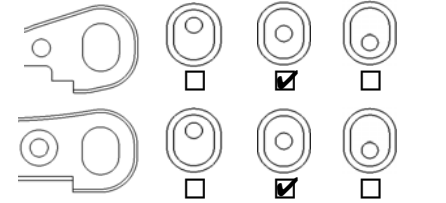

Steering ackerman

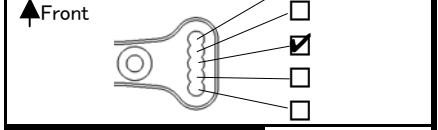

Front upper plate

E2148D E2158(CFRP)

Servo saver arm

E2301A E2310(Aluminum)

Rear suspension

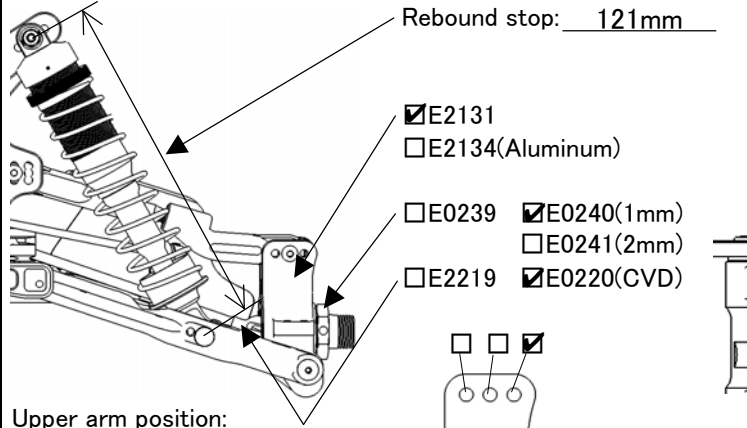

Ride height: 28mm
 Camber angle: 19mm
 Lower arm plate:
 E2145A,B
 E2156(CFRP 1mm)
 E2157(CFRP 1.2mm)
 Anti roll bar: ϕ 2.7
 Lower arm spacer: 1mm

Rear shocks

Piston: 8x1.3 Oil: #500
 Spring: 10.5
 Shock position:

 Pivot ball position: Front Rear
 Damper stay: E2563(Aluminum)
 E2566(CFRP)

Upper arm position:

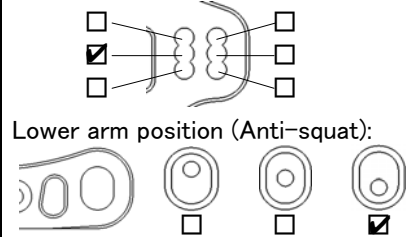

Lower arm position (Toe angle):

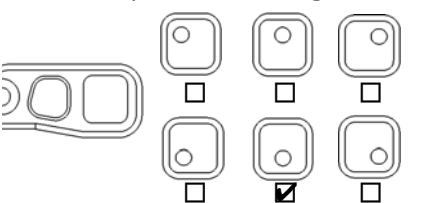

Center shaft

E0223,E0259 E2228,E2229

Tension rod

Front: E2107A(Long) E2107B(Short)
 Rear: E2148C E0803(Rubber)

Weight



Engine

Type: Ninja JX21-B04 Plug: P3 Reducer: 6.5mm
 Muffler: Ninja 2089 Fuel: _____ Gasket: _____
 Engine mount: E0701(Standard) Other One piece

Diff. Gear

Oil
 Front: 44/13T 42/12T #5,000
 Rear: 44/13T 42/12T #3,000
 Center: 44T 46T #5,000
 47T 48T

Tires

	Front	Rear
Type:	<u>HotRace Amazonia</u>	<u>HotRace Amazonia</u>
Compound:	<u>Soft</u>	<u>Soft</u>
Inserts:	<u>Standard</u>	<u>Standard</u>
Wheel:	<u>Standard</u>	<u>Standard</u>

Clutch

3P 4P
 Clutch bell: 13T 14T
 Clutch shoes C0754 E0704 E0710 E2706
 Clutch spring 0.8 0.9 0.95 1.0 1.05 1.1

Body/Wing

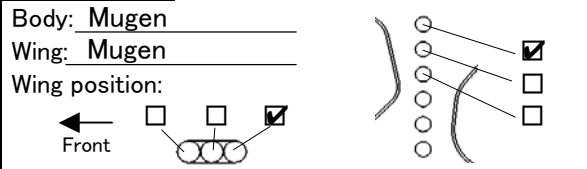

Comments

.....

