

Name: Ricardo Monteiro
 Date: NEO 2018
 Track: RC Redovan, Spain

Track conditions

Size: Open Med. Tight
 Traction: High Med. Low
 Surface: Smooth Med. Bumpy

Result

Race time / Lap: _____
 Best lap (1Lap): _____

Front suspension

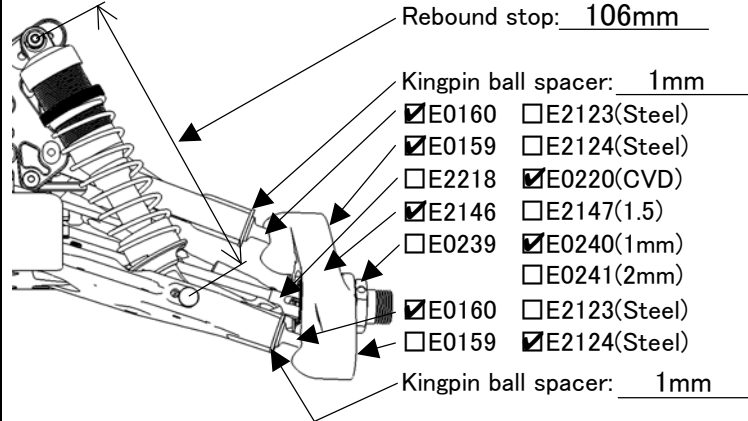

Ride height: 23mm
 Toe angle: 25.5mm
 Lower arm plate:
E2144A,B
E2154(CFRP 1mm)
E2155(CFRP 1.2mm)
 Anti roll bar: ϕ 2.3
 Upper arm spacer: 3mm
 Lower arm spacer: 0mm

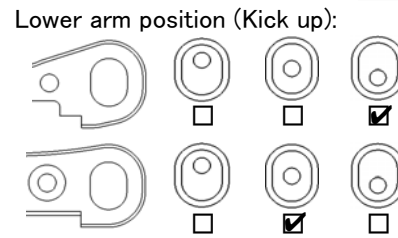
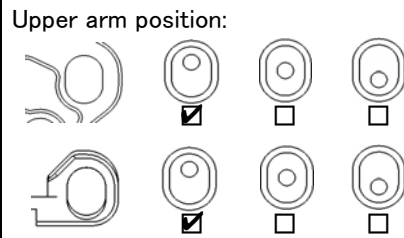

Front shocks

Piston: VRP 8x1.2 Oil: XTR 550
 Spring: 9.25
 Shock position:

 Pivot ball position: Front Rear
 Damper stay: E2562(Aluminum)
E2565(CFRP)

Steering ackerman

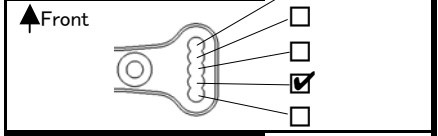

Front upper plate

E2148D E2158(CFRP)

Servo saver arm

E2301A E2310(Aluminum)

Rear suspension

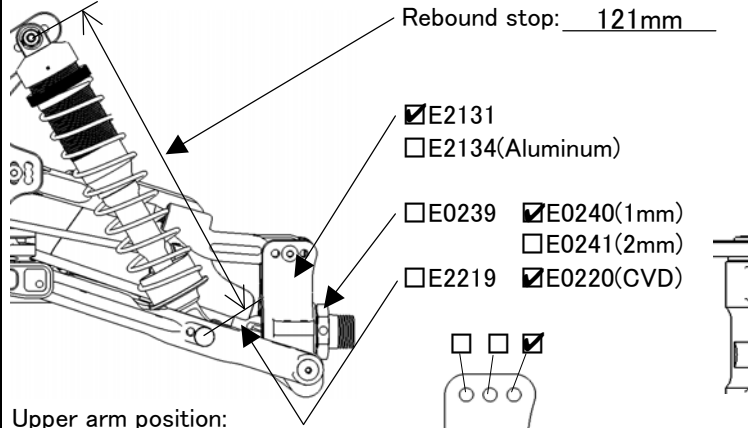

Ride height: 27mm
 Camber angle: 19mm
 Lower arm plate:
E2145A,B
E2156(CFRP 1mm)
E2157(CFRP 1.2mm)
 Anti roll bar: ϕ 2.7
 Lower arm spacer: 1mm
 Upright spacer: 0mm

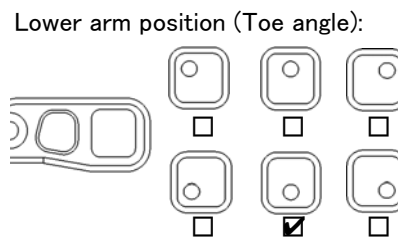
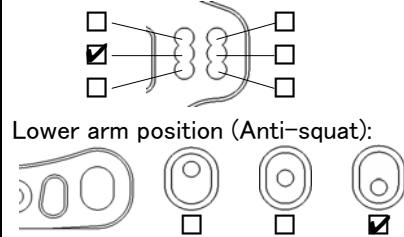

Rear shocks

Piston: VRP8x1.3 Oil: XTR 700
 Spring: 10.5
 Shock position:

 Pivot ball position: Front Rear
 Damper stay: E2563(Aluminum)
E2566(CFRP)

Center shaft

E0223,E0259 E2228,E2229

Tension rod

Front: E2107A(Long) E2107B(Short)
 Rear: E2148C E0803(Rubber)

Weight



Engine

Type: Reds WR7 Plug: Reds 5 Reducer: _____
 Muffler: Reds 2143 Fuel: NITROLUX 25 Gasket: _____
 Engine mount: E0701(Standard) Other One piece

Diff. Gear

Oil
 Front: 44/13T 42/12T #10,000
 Rear: 44/13T 42/12T #3,000
 Center: 44T 46T #6,000
47T 48T

Tires

	Front	Rear
Type:	<u>HotRace Miami</u>	<u>HotRace Miami</u>
Compound:	<u>Medium</u>	<u>Medium</u>
Inserts:	<u>Standard</u>	<u>Standard</u>
Wheel:	<u>Black</u>	<u>Black</u>

Clutch

3P 4P
 Clutch bell: 13T 14T
 Clutch shoes C0754 E0704 E0710 E2706
 Clutch spring 0.8 0.9 0.95 1.0 1.05 1.1

Body/Wing

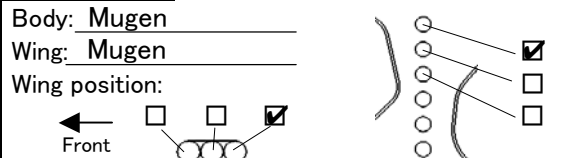

Comments

.....

